



PRIZMA

www.prizmalift.com







imalat - manufacturing

ASANSÖR SİSTEMİ
LIFT SYSTEM

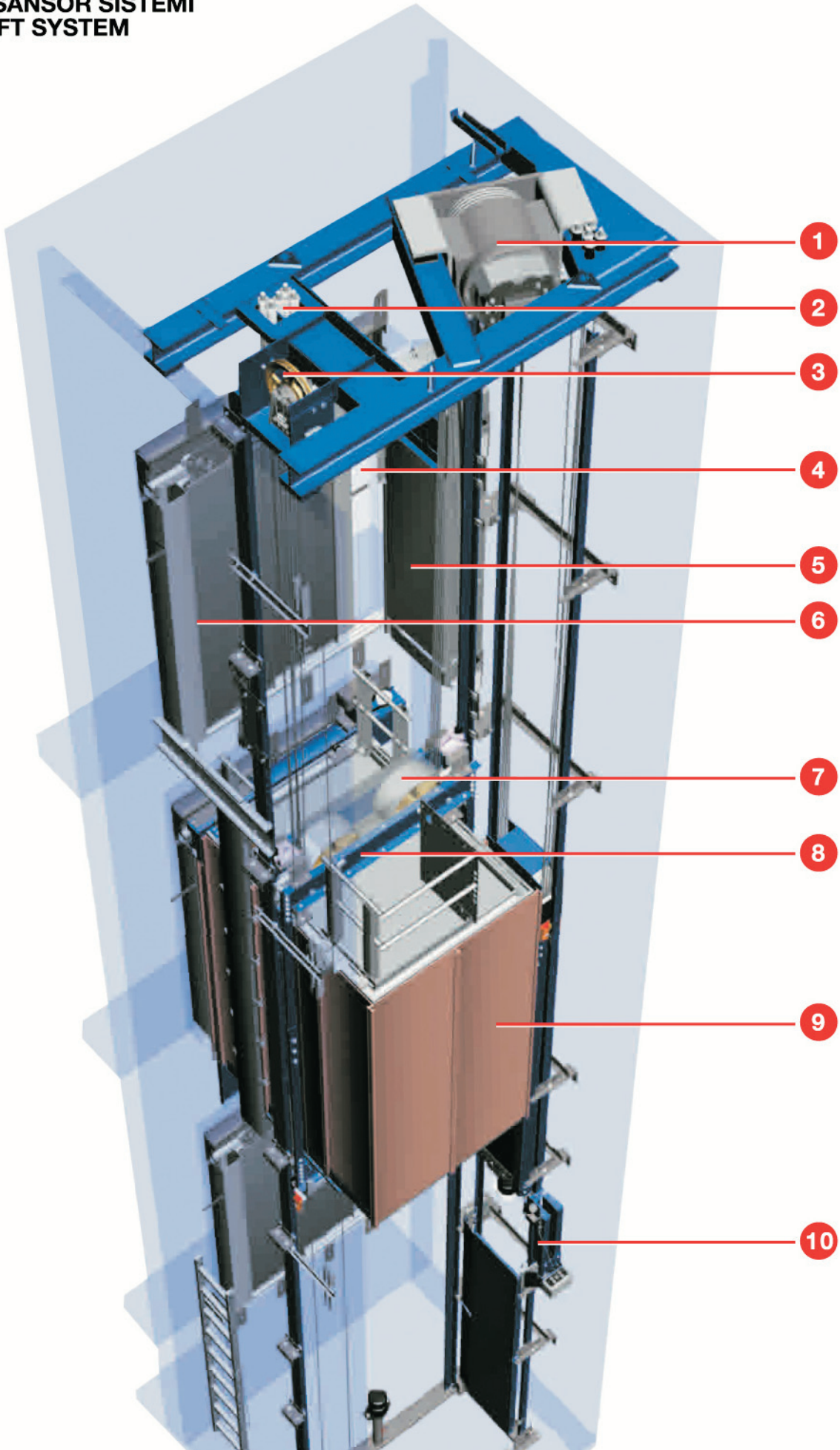



1
Makina
Drive



3
Hız Kesici
Overspeed Governor



5
Ağırlık
Weight



7
2:1 Palanga Sistemi
2:1 Pulleys



9
Kabin
Elevator Car



2
Halat Tutucuları
Rope Fastenings



4
Kumanda Panosu
Control Panel



6
Kat Kapısı
Door



8
Karkas
Safety Gear TCS



10
Kılavuz Rayı
Guide Rail

YÜRÜYEN MERDİVEN VE BANT SİSTEMİ
ESCALATOR / WALKING WAYS





1

El Bandı
Hand Band



2

Basamak
Step

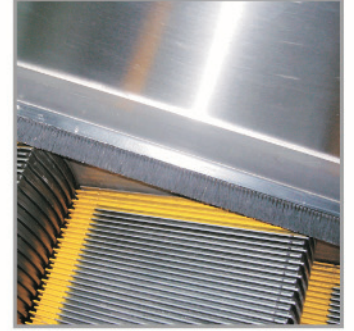

3

Süpürgelik
Baseboard



4

Korkuluk
Barrier

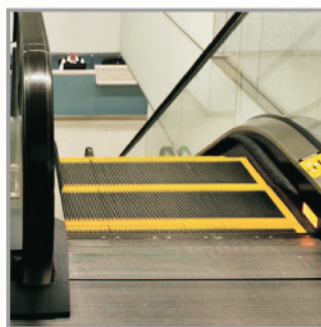

5

Tarak
Comb



6

Kaplama
Guard Cover

LAMİNANT KABİNLER / LAMINATE CARS



Yan Duvar	: Laminant
Arka Duvar	: Yarımboy Ayna
Taban	: Antibakteriyel
Tavan	: Endirekt Aydınlatma
Aksesuar	: Satine Paslanmaz
Küpeşte	: 2 Adet

Side Wall	: Laminate
Back Wall	: Half Hight Mirror
Floor	: Antibacterial
Ceiling	: Indirect Lighting
Accessories	: Stainless Steel
Handrail	: 2 PCS



Yan Duvar	: Laminant
Arka Duvar	: Tamboy Ayna
Taban	: Granit
Tavan	: Endirekt Aydınlatma
Aksesuar	: Satine Paslanmaz
Küpeşte	: 1 Adet

Side Wall	: Laminate
Back Wall	: Full Hight Mirror
Floor	: Granite
Ceiling	: Indirect Lighting
Accessories	: Stainless Steel
Handrail	: 1 PC

LAMİNANT KABİNLER / LAMINATE CARS



Yan Duvar	: Laminant
Arka Duvar	: Tamboy Ayna
Taban	: Antibakteriyel
Tavan	: Endirekt Aydınlatma
Aksesuar	: Satine Paslanmaz
Küpeşte	: 2 Adet

Side Wall	: Laminate
Back Wall	: Full Hight Mirror
Floor	: Antibacterial
Ceiling	: Indirect Lighting
Accessories	: Stainless Steel
Handrail	: 2 PCS



Yan Duvar	: Laminant
Arka Duvar	: Tamboy Ayna
Taban	: Granit
Tavan	: Endirekt Aydınlatma
Aksesuar	: Satine Paslanmaz
Küpeşte	: 2 Adet

Side Wall	: Laminate
Back Wall	: Full Hight Mirror
Floor	: Granite
Ceiling	: Indirect Lighting
Accessories	: Stainless Steel
Handrail	: 2 PCS

PASLANMAZ KABİNLER / STAINLESS CARS



Yan Duvar : Paslanmaz
Arka Duvar : Tamboy Ayna
Taban : Granit
Tavan : Endirekt Aydınlatma
Aksesuar : Paslanmaz
Küpeşte : 3 Adet

Side Wall : Stainless Steel
Back Wall : Full Hight Mirror
Floor : Granute
Ceiling : Indirect Lighting
Accessories : Stainless Steel
Handrail : 3 PCS



Yan Duvar : Paslanmaz
Arka Duvar : Tamboy Ayna
Taban : Granit
Tavan : Endirekt Aydınlatma
Aksesuar : Laminant
Küpeşte : 3 Adet

Side Wall : Stainless Steel
Back Wall : Full Hight Mirror
Floor : Granute
Ceiling : Indirect Lighting
Accessories : Laminant
Handrail : 3 PCS

PANOROMİK KABİNLER / PANOROMIC CARS



Yan Duvar : Paslanmaz
Arka Duvar : Cam
Taban : Antibakteriyel
Tavan : Endirekt Aydınlatma
Aksesuar : Satine Paslanmaz
Küpeşte : 2 Adet

Side Wall : Stainless Steel
Back Wall : Glass
Floor : Antibacterial
Ceiling : Indirect Lighting
Accessories : Stainless Steel
Handrail : 2 PCS



Yan Duvar : Paslanmaz
Arka Duvar : Cam
Taban : Granit
Tavan : Endirekt Aydınlatma
Aksesuar : Satine Paslanmaz
Küpeşte : 2 Adet

Side Wall : Stainless Steel
Back Wall : Glass
Floor : Granite
Ceiling : Indirect Lighting
Accessories : Stainless Steel
Handrail : 2 PCS

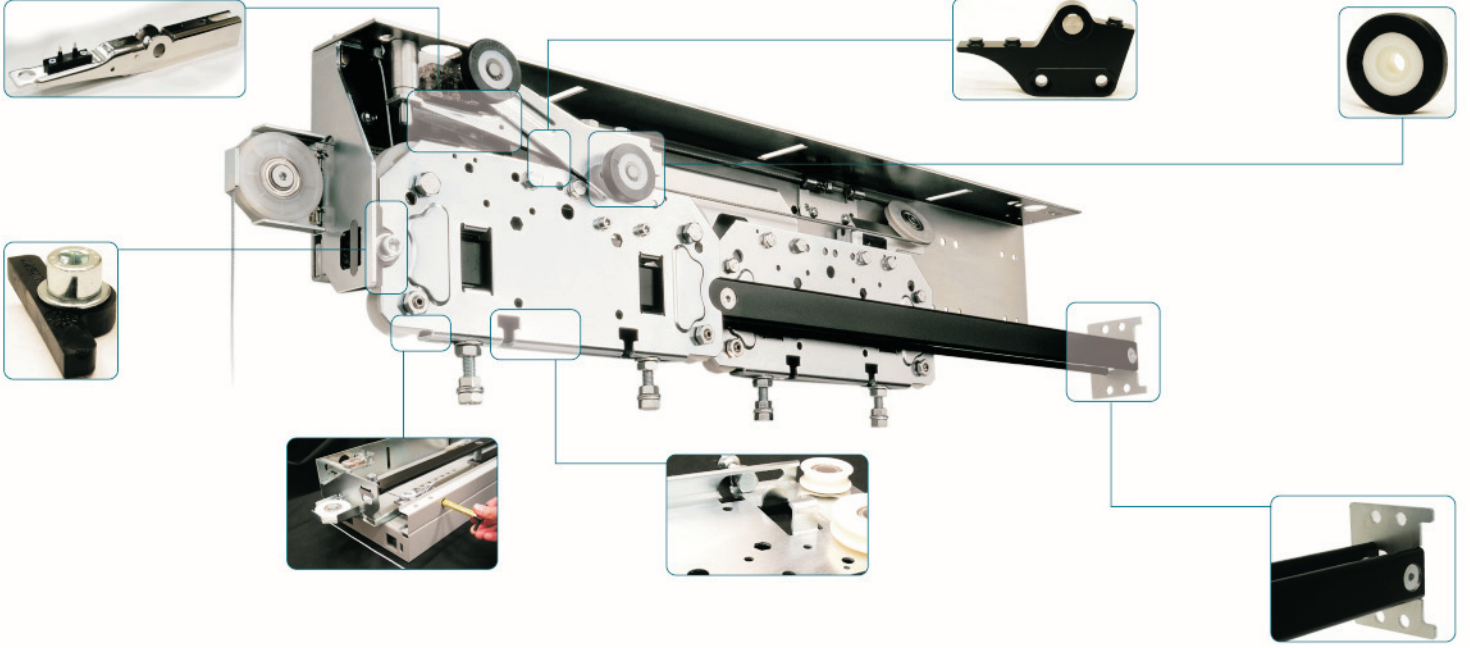

SERIE Q

TAM OTOMATİK KAT ve KABİN KAPILARI

Dünyanın en prestijli ve sorunsuz kapı mekanizmalarından

600 mm - 4000 mm ürün çeşitliliği

Hem Mekanik hem VVVF kontrolü

Sınırsız yedek parça ve servis garantisi

Boyali, paslanmaz, yan cam, tam cam, panel vitray cam seçenekleri ile geniş ürün ağı

FULL AUTOMATIC LANDING & CABIN DOOR

Made of the most prestigious and free of problem automatic door mechanisms

600 mm - 4000 mm Product Range

Both Mechanical and VVVF control

Unlimited spare parts and service guarantee

Wide product range with painted, stainless, framed glass, full glass, panel, stained glass option

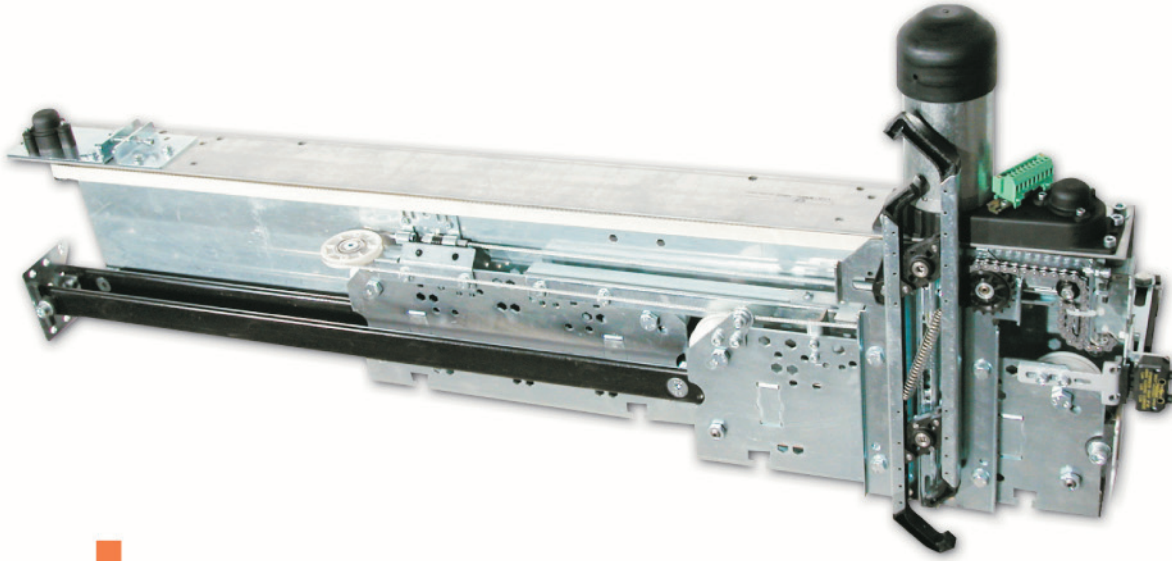

MICRO

Revizyon için ideal, Makine dairesiz ya da geniş olmayan makine dairesi için tavsiye edilir. Geniş çalışma alanı olmayan ölçüler ve dar eşik alanları için uygundur.

Ideal for modernization, recommended for MRL installations, Reduced overall dimensions the footprint is as narrow as the sill.

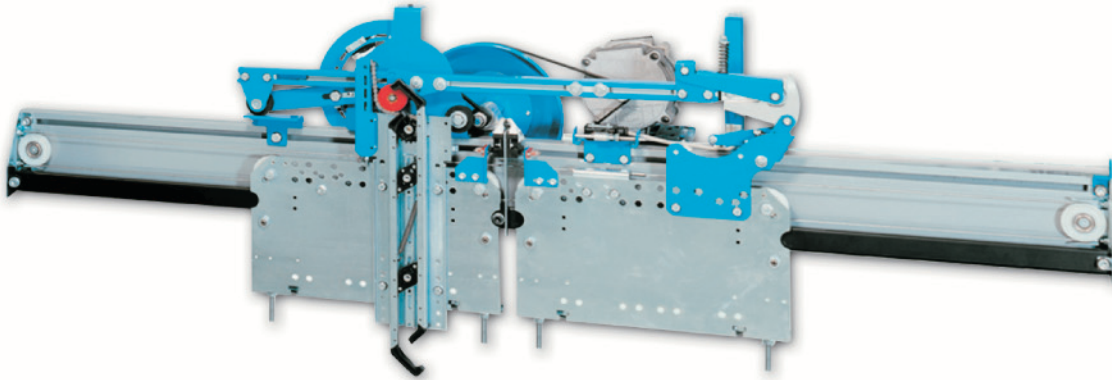

D.O.S.

Sinus DOS PRISMA srl tarafından aralıksız yapılan araştırmaların ürünüdür. Mekanik kollu kabin operatörü, sinusoidal çalışma sistemiyle ve kattan ayar ve bakım imkanıyla son derece konforlu bir mekanizmadır.

Sinus DOS is the result of continuous research by PRISMA srl. Sinus is the exclusive arm operator with sinusoidal motion, on which all cabling adjusting, repairing and maintenance operations are possible standing comfortably on the landing.

OTOMATİK KAPILAR / AUTOMATIC DOORS



Paslanmaz

600 mm - 4000 mm ürün çeşitliliği

Stainless Steel

600 mm - 4000 mm Product Range



Paslanmaz ve Cam

600 mm - 4000 mm ürün çeşitliliği

Stainless Steel and Glass

600 mm - 4000 mm Product Range

OTOMATİK KAPILAR / AUTOMATIC DOORS

**Tam Cam**

600 mm - 4000 mm ürün çeşitliliği

Full Glass

600 mm - 4000 mm Product Range

**Özel Paslanmaz ve Cam**

600 mm - 4000 mm ürün çeşitliliği

Special Stainless Steel and Glass

600 mm - 4000 mm Product Range

YARI OTOMATİK KAPILAR / SWING DOORS



**Özel Paslanmaz
Özel Kol ve Çerçeve Tasarımı
120° Açılabilme Özelliği
Yüksek Taşıma Kapasiteli Menteşe
Sorunsuz Kullanım**

Special Stainless Steel
Special Hand and Frame Design
Possibility to Open With 120°
Hinges With high Carrying Capacity
Usage Without Problem



**Özel Paslanmaz
Özel Kol ve Çerçeve Tasarımı
120° Açılabilme Özelliği
Yüksek Taşıma Kapasiteli Menteşe
Sorunsuz Kullanım**

Special Stainless Steel
Special Hand and Frame Design
Possibility to Open With 120°
Hinges With high Carrying Capacity
Usage Without Problem

YARI OTOMATİK KAPILAR / SWING DOORS



Elektrostatik Boya
Kol ve Çerçeve Tasarımı
120° Açılabilme Özelliği
Yüksek Taşıma Kapasiteli Menteşe
Sorunsuz Kullanım

ESP
Hand and Frame Design
Possibility to Open With 120°
Hinges With High Carrying Capacity
Usage Without Problem

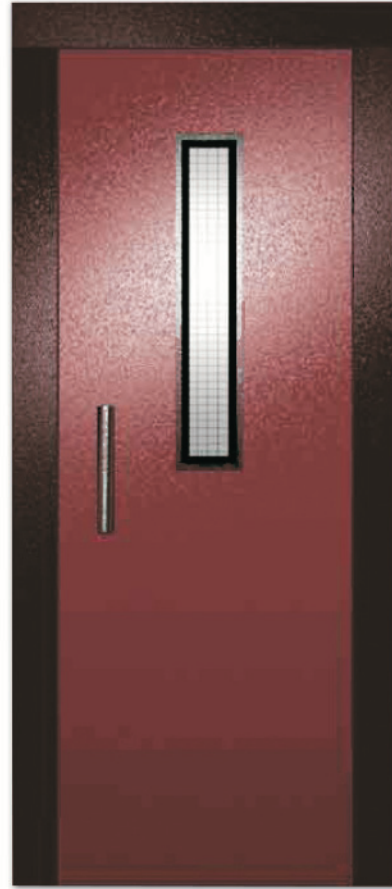

Elektrostatik Boya
Kol ve Çerçeve Tasarımı
120° Açılabilme Özelliği
Yüksek Taşıma Kapasiteli Menteşe
Sorunsuz Kullanım

ESP
Hand and Frame Design
Possibility to Open With 120°
Hinges With High Carrying Capacity
Usage Without Problem

YÜK KAPILARI / FREIGHT DOORS



Gizli menteşeli kapılarda 135°,
özel çelik menteşeli kapılarda 180°
açılabilme sağlayan sistem
Kasalar 2mm DKP sac
Ayarlı tampon lastikleri
Özel form verilmiş çerçeve ve kol profili

Hinging system that ensures 135-180
degree opening
Frames 2mm DKP sheet
Adjusted buffer stops
Specially formed frame and arm profile



Gizli menteşeli kapılarda 135°,
özel çelik menteşeli kapılarda 180°
açılabilme sağlayan sistem
Kasalar 2mm DKP sac
Ayarlı tampon lastikleri
Özel form verilmiş çerçeve ve kol profili

Hinging system that ensures 135-180
degree opening
Frames 2mm DKP sheet
Adjusted buffer stops
Specially formed frame and arm profile

DİĞER ÜRÜNLER / OTHER PRODUCTS

**SERVİS KABİNLERİ**

Mukavemeti arttırılmış tavan/tabán sistemi
 Özel monte taşıyıcı karkas sistemi
 Hareketli raf sistemi
 Lir tahrik mekanizması

SERVICE CABINS

Reinforced ceiling / floor system
 Special mounted carrying car siling system
 Moving shelf system

**KATLANABİLİR KAPI**

Fonksiyonel elektronik kart
 Özel alüminyum profil
 Alt kısımlarda rulmanlı yatak

FOLDING DOOR

Functional electronic card
 Special aluminium profile
 Roller bearings at lower sections

PRISMA

Serie



SERIE



Dişlisiz Makine Dairesiz Sistemler

Taşıma kapasitesi 100 kg dan 8000 kg'a kadar frekans kontrollü makine-motor grupları 0.63 - 3.00 m/s hızları arasında değişen makine seçenekleri

Gearless MRL Systems

Carrying capacity between 100kg-8000 kg VVVF gearless machine system

Machine alternatives between 0.63-3.00 m/s speed

Dişli Sistemler

Taşıma kapasitesi 100 kg dan 4000 kg a kadar dişli makine motor grupları 0.20 - 1.60 m/s hızları arasında değişen makine seçenekleri

Geared Systems

Carrying capacity between 100 kg - 4000 kg geared machine systems Machine alternatives between 0.20-1.60 m/s speed

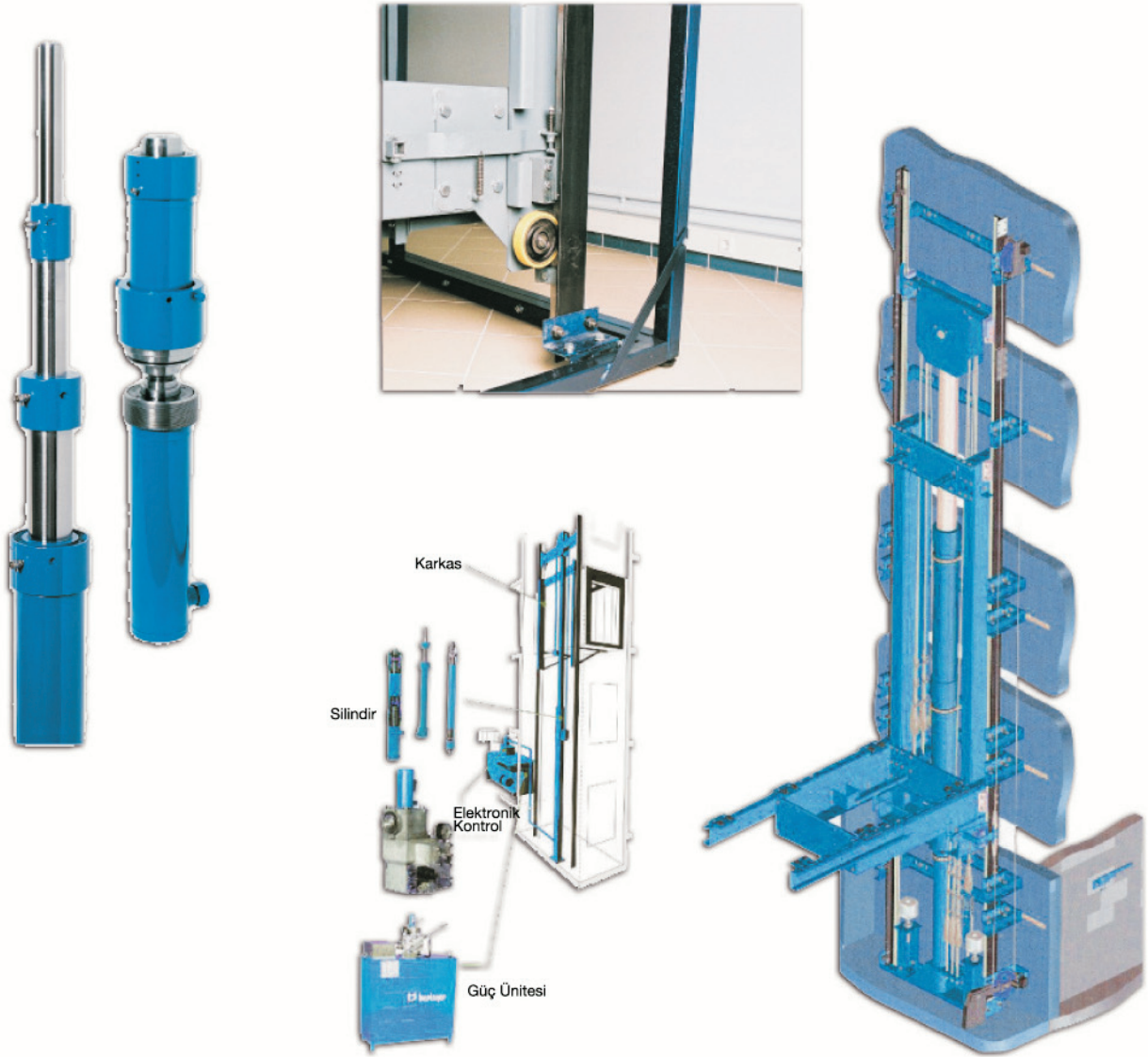

Hidrolik sistem

Kısa seyir mesafeli binalarda, yüksek taşıma kapasitelerinde ve düşük hızlarda oldukça avantajlı bir uygulama şeklidir. Ayrıca kuyusu bulunmayan binalarda yeterli merdiven boşluğunun olmaması durumunda sonradan da inşa edilebilmektedirler.

Hydraulic Systems

Highly advantageous for the buildings with short cruising, having high carrying capacities at low speeds. In addition, in buildings which have no shaft and no sufficient stairwell area, it is possible to construct them also afterwards.

DOKUNMATİK BUTONLAR / OPERATION PANELS



PASLANMAZ BUTONLAR / STAINLESS PANELS

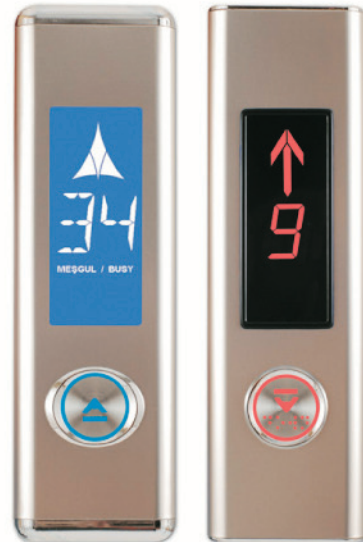



REFERANSLARIMIZDAN BAZILARI

REFERENCES



PRiZMA

ASANSÖR SANAYİ - LIFT COMPANY

WWW.PRIZMALIFT.COM



PRIZMA

100. Yıl Bulvarı No: 51/3 Muratpaşa - Antalya / Türkiye
Tel: +90.242 247 28 38 - Fax:+90.242 247 94 85
www.prizmalift.com - info@prizmalift.com